

Z●IN

Collection
2022

Our Expertise, Your Dream

OUR FUNCTIONALITY



Carne
Meat
Viande
Fleisch



Bevande
Drinks
Boissons
Getränke



Larghezza in cm.
Width in cm.
Largeur en cm.
Breite in cm.



Salumi - Formaggi
Sausages - Cheese
Charcuterie - Produits Laitiers
Wurstwaren - Milchprodukte

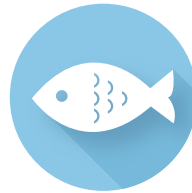

Pesce
Fish
Poisson
Fisch



Lunghezza in cm.
Length in cm.
Longueur en cm.
Länge in cm.

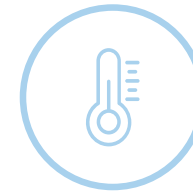

Classe climatica
Climate class
Classe climatique
Klima-Klasse



Gastronomia
Deli
Deli
Deli



Frutta e Verdura
Fruits and Vegetables
Fruits et Legumes
Obst und Gemüse



Profondità ripiano in cm.
Shelf Depth in cm.
Profondeur étagère en cm.
Regal-Tiefe in cm.



Pasticceria
Pastry
Pâtisserie
Bäckerei



Sushi

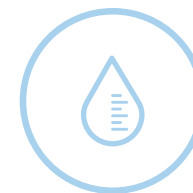

Capacità di carico in lt.
Load capacity in lt.
Capacité de charge en lt.
Tragfähigkeit in lt.

MELODY



Un modello senza tempo.

Melody è sinonimo di tradizione e robustezza, un modello che non segue le mode del momento. L'abbiamo progettato per la presentazione e la vendita di salumi, formaggi e altri prodotti di gastronomia.

A timeless model.
Melody rhymes with tradition and robustness without conforming with new trends. It has been designed for the display of cold cuts, cheese and gastronomic products in general.

Un modèle intemporel.
Melody est synonyme de tradition et de robustesse, un modèle qui ne suit pas les modes actuelles. Nous l'avons conçu pour la présentation et la vente de charcuteries, de fromages et d'autres produits préparés.

Ein zeitloses Modell.
Melody ist ein Synonym für Tradition und Stabilität, ein Modell, das sich nicht an den Moden des Augenblicks orientiert. Wir haben es für die Präsentation und den Verkauf von Wurstwaren, Käse und anderen gastronomischen Produkten konzipiert.

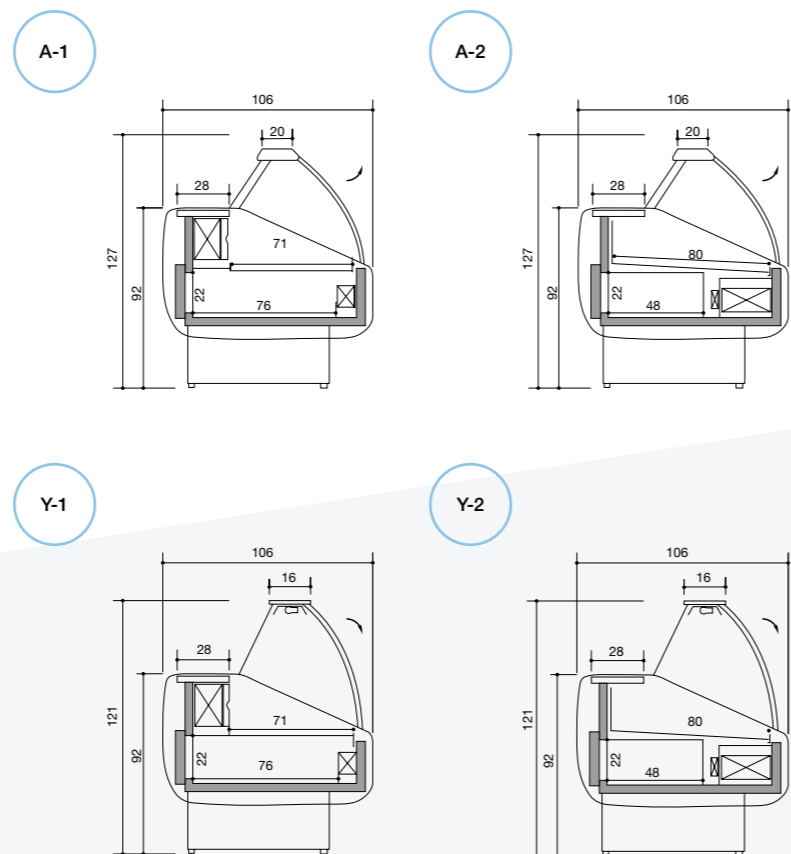

1

illuminazione LED.
LED lighting.
Éclairage LED.
LED-Beleuchtung.

2

Zona esposizione in acciaio inox.
Display area in stainless steel.
Zone d'exposition en acier inox.
Auslagefläche aus Edelstahl.

3

Piano lavoro in granito (Rosa Beta).
Working plate in granit (Rosa Beta).
Plan de travail en granit (Rosa Beta).
Arbeitsplatte aus (Rosa Beta).

4

A1- A2: Struttura servoassistita.
A1- A2: Servo-assisting upsetting glass.
A1- A2: Overture servoassistite.
A1- A2: Hebescheibenstruktur.

5

Y1-Y2: vetri apribili a compasso.
Y1-Y2: bottom-hung glass.
Y1-Y2: vitre rabattable.
Y1-Y2: Gerade Kippscheiben.



Gray

Colori spalla
End colours
Couleurs des côtés
Farben für Rückwände



Width in cm.
106







Length in cm.
150 · 200 · 250
300 · 350 · 400

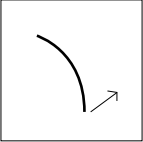
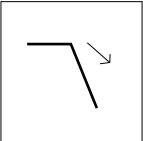

Climate class
3 M2
25°C / u.r. 60%

D96 Red Version Y-2

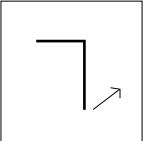
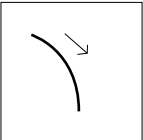
SERVE-OVER

A		VETRO CURVO APRIBILE VERSO L'ALTO
B		VETRO DRITTO APRIBILE A COMPASSO
C		VETRO RETTO APRIBILE A COMPASSO
D		VETRO RETTO APRIBILE VERSO L'ALTO
Y		VETRO CURVO APRIBILE A COMPASSO
S		VETRO SELF SERVICE

1	STATICO CON CELLA
2	VENTILATO CON CELLA
3	STATICO SENZA CELLA
4	VENTILATO SENZA CELLA
5	CALDO
6	NON REFRIGERATO
7	CON SUPPORTO E RUOTE
8	SENZA SUPPORTO E RUOTE
FISH	VERSIONE PER PESCE

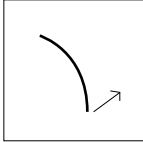
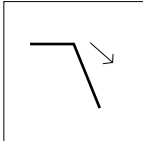
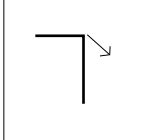
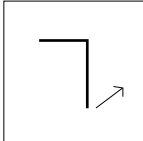
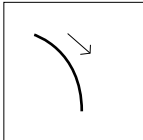
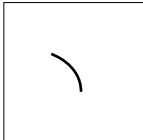
A		CURVED GLASS OPENING UPWARDS
B		STRIGHT GLASS OPENING DOWNWARDS
C		VERTICAL GLASS OPENING DOWNWARDS
D		STRIGHT GLASS OPENING UPWARDS
Y		CURVED GLASS OPENING DOWNWARDS
S		GLASS SELF SERVICE

1	STATIC WITH COOL STORAGE
2	STATIC WITH COOL STORAGE
3	STATIC WITHOUT COOL STORAGE
4	VENTILATED WITHOUT COOL STORAGE
5	HOT-SECTION
6	NOT REFRIGERATED
7	WITH SUPPORT AND CASTORS
8	WITHOUT SUPPORT AND CASTORS
FISH	FISH VERSION

COLORI

Colori disponibili
Available colors
Couleurs disponibles
Verfügbare Farben

Batticarrello
Bumpers
Pare-chocs
Stoßfänger

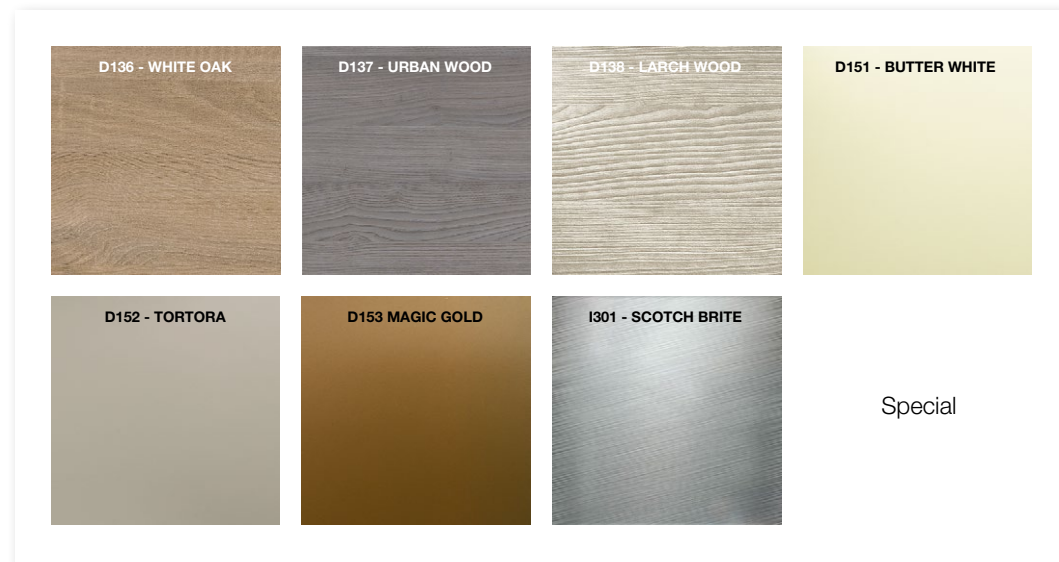
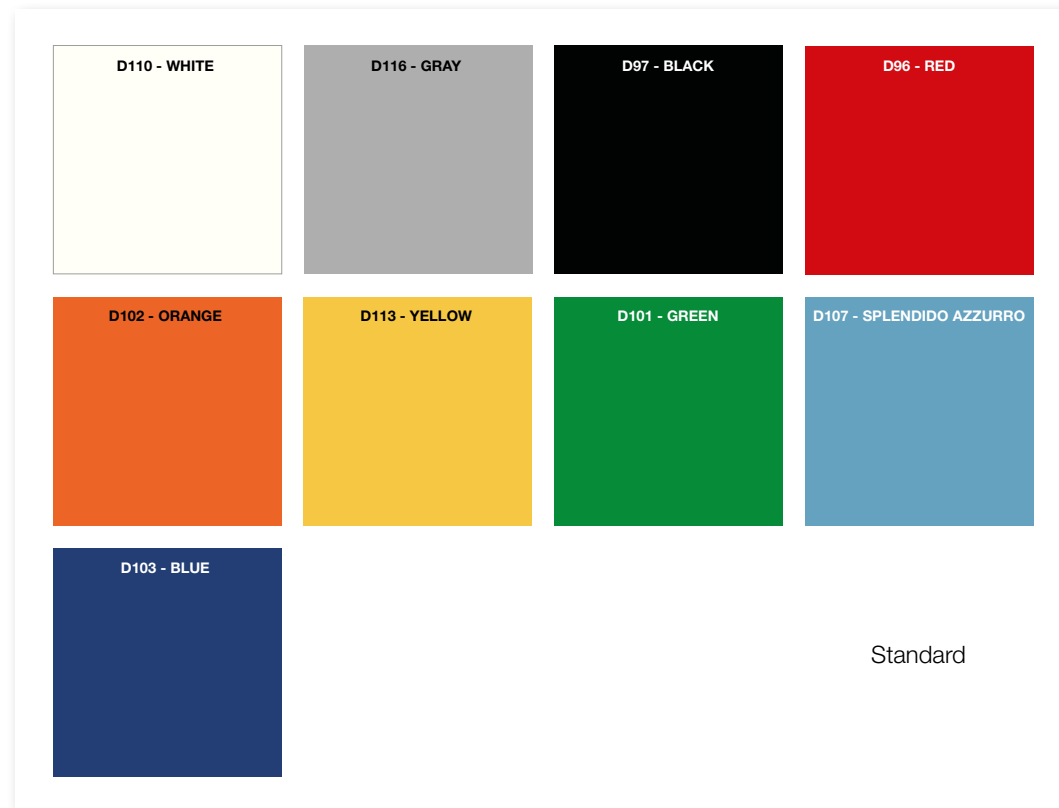
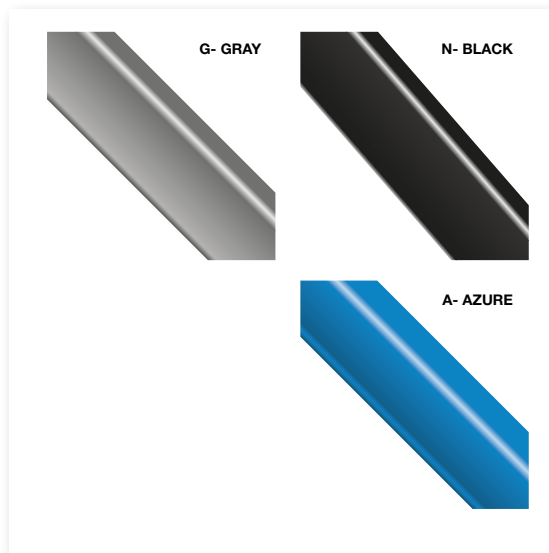



GLOBAL COOLING

ZOIN Srl

Via Roma n. 320/1,
35030, CERVARESE SANTA CROCE (PD) - ITALY
Tel. (+39) 049 907 0172
www.zoin.it zoin@zoin.it